

Delaware Basin Monitoring Annual Report



September 2012

**United States Department of Energy
Waste Isolation Pilot Plant**

**Carlsbad Field Office
Carlsbad, New Mexico**

This document has been submitted as required to:

Office of Scientific and Technical Information
PO Box 62
Oak Ridge, TN 37831
(615) 576-8401

Additional information about this document may be obtained by calling 1-800-336-9477. Copies may be obtained by contacting the National Technical Information Service, US Department of Commerce, 5285 Port Royal Road, Springfield, VA 22101.

Delaware Basin Monitoring Annual Report

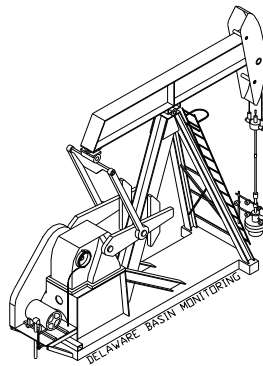

September 2012

**United States Department of Energy
Waste Isolation Pilot Plant**

**Carlsbad Field Office
Carlsbad, New Mexico**

Prepared for
the **Department of Energy** by
**Washington TRU Solutions Regulatory Compliance
Delaware Basin Drilling Surveillance Program**

This page intentionally left blank

Table of Contents

1.0	Delaware Basin Drilling Surveillance Program	1
2.0	2012 Updates	2
2.1	Miscellaneous Drilling Information	2
2.1.1	Drilling Techniques	3
2.1.2	Drilling Fluids	4
2.1.3	Air Drilling	4
2.2	Shallow Drilling Events	6
2.3	Deep Drilling Events	6
2.4	Past Drilling Rates	7
2.5	Current Drilling Rate	8
2.5.1	Nine-Township Area Drilling Activities	8
2.5.2	Drilling Activities Outside the Nine-Township Area	8
2.6	Castile Brine Encounters	9
2.7	Borehole Permeability Assessment - Plugging Practices	9
2.8	Seismic Activity in the Delaware Basin	11
2.9	Secondary and Tertiary Recovery	11
2.9.1	Nine-Township Injection Wells	12
2.9.2	Nine-Township Salt Water Disposal Wells	12
2.10	Mining	13
2.10.1	Potash Mining	13
2.10.2	Sulfur Extraction	13
2.10.3	Solution Mining	14
2.11	New Drilling Technology	15
2.12	Alternative Energy Activities	15
3.0	Survey of Well Operators for Drilling Information	15
4.0	Summary - 2012 Delaware Basin Drilling Surveillance Program	16
5.0	References	17

List of Figures

Figure 1: WIPP Site, Delaware Basin, and Surrounding Area	18
Figure 2: Typical Well Structure and General Stratigraphy Near the WIPP Site	19
Figure 3: Oil and Gas Wells within One Mile of the WIPP Site	20
Figure 4: Typical Borehole Plug Configurations in the Delaware Basin	21
Figure 5: Typical Injection or Salt Water Disposal Well (SWD)	22
Figure 6: Active Injection and SWD Wells in the Nine-Township Area	23
Figure 7: Potash Mining in the Vicinity of the WIPP Site	24
Figure 8: Active Brine Well Locations in the Delaware Basin	25

List of Tables

Table 1: Nine-Township Area Casing Sizes	26
Table 2: Nine-Township Area Bit Sizes	26
Table 3: Air-Drilled Wells in the New Mexico Portion of the Delaware Basin	27
Table 4: Shallow Well Status in the Delaware Basin	28
Table 5: Deep Well Status in the Delaware Basin	29
Table 6: Drilling Rates for the Delaware Basin	30
Table 7: Castile Brine Encounters in the Vicinity of the WIPP Site	31
Table 8: Plugged Well Information	33
Table 9: Past Plugging Summary by Well Type	35
Table 10: Current Plugging Summary by Well Type for the CRA-2014	35
Table 11: Seismic Activity in the Delaware Basin	36
Table 12: Nine-Township Injection and SWD Well Information	37
Table 13: Brine Well Status in the Delaware Basin	39

1.0 Delaware Basin Drilling Surveillance Program

The Delaware Basin Drilling Surveillance Program (DBDSP) is designed to monitor drilling activities in the vicinity of the Waste Isolation Pilot Plant (WIPP) Site. This program is based on Environmental Protection Agency (EPA) criteria in Title 40 Code of Federal Regulations (CFR) Part 194.33. The EPA environmental radiation protection standards for the management and disposal of spent nuclear fuel, high-level and transuranic radioactive wastes are codified in 40 CFR Part 191 (DOE 1996). Subpart B of the standard addresses the disposal of radioactive waste. The standard requires the Department of Energy (DOE) to demonstrate the expected performance of the disposal system using a probabilistic risk assessment or performance assessment (PA). The results of the PA must show the expected repository performance will not result in the release of radioactive material above EPA limits. This assessment includes the consideration of inadvertent human intrusion into the repository.

In 40 CFR Part 194 (EPA 1996), the EPA defined the geographical area for the evaluation of the historical rate of drilling for resources as the Delaware Basin. This same area is to be used for monitoring mining, drilling, and drilling-related activities. The definition of the Delaware Basin in 40 CFR § 194.2 is:

“Delaware Basin means those surface and subsurface features which lie inside the boundary formed to the north, east and west of the [WIPP] disposal system, by the innermost edge of the Capitan Reef, and formed, to the south, by a straight line drawn from the southeastern point of the Davis Mountains to the most southwestern point of the Glass Mountains.”

The Delaware Basin, depicted in Figure 1, includes all or part of Brewster, Culberson, Jeff Davis, Loving, Pecos, Reeves, Ward, and Winkler counties in west Texas, and portions of Eddy and Lea counties in southeastern New Mexico.

The DOE continues to provide surveillance of the mining and drilling activity in the Delaware Basin in accordance with the criteria established in 40 CFR Part 194. This will continue until the DOE and the EPA mutually agree no further benefit can be gained from continued surveillance. The results of the ongoing surveillance will be used to determine if a significant and detrimental change has occurred that would affect the performance of the disposal system.

The *Delaware Basin Drilling Surveillance Plan* (WP 02-PC.02) places specific emphasis on the nine-township area surrounding the WIPP Site, which includes townships 21 through 23 south and ranges 30 through 32 east in southeastern New Mexico. The DBDSP provides data to build on the information presented in the Compliance Certification Application (CCA), Appendix DEL (DOE 1996), the Compliance Recertification Application-2004 (CRA-2004), Appendix DATA (DOE 2004), and the Compliance Recertification Application-2009 (CRA-2009), Appendix DATA (DOE 2009).

2.0 2012 Updates

The PA is required by 40 CFR §194.33 to consider disturbed case scenarios that include intrusions into the repository by inadvertent and intermittent drilling for resources. The data provided in this report covers the period from September 1, 2011 to August 31, 2012. The probability of these intrusions is based on a future drilling rate of 46.8 boreholes per square kilometer per 10,000 years which was established for the CCA, Appendix DEL, 52.5 boreholes per square kilometer for the CRA-2004, Appendix DATA, and 58.5 boreholes per square kilometer for CRA-2009, Appendix DATA. These rates are based on consideration of the record of drilling events in the Delaware Basin for the most recent 100-year period. The DOE models multiple types of human intrusion scenarios in the PA. These include both single intrusion events and combinations of multiple boreholes.

Two different types of boreholes are considered: (1) those that penetrate a pressurized brine reservoir in the underlying Castile Formation and (2) those that do not. While the presence of pressurized brine under the repository is speculative, it cannot be completely ruled out based on available information. The primary consequence of contacting pressurized brine is the introduction of an additional source of brine beyond that which is assumed to be released into the repository from the Salado Formation. The human intrusion scenario models are based on extensive field data sets collected by the DOE. The DBDSP collects the drilling-related data to be used for future PA calculations. The data have been continuously collected from the time of the 1996 submittal of the CCA and include specific wells drilled during the last year in the New Mexico portion of the Delaware Basin, specifically that of the nine-township area immediately surrounding the WIPP Site. These data are summarized in the following sections.

2.1 Miscellaneous Drilling Information

The EPA provided criteria in 40 CFR §194.33(c) to address the consideration of drilling in the PA. These criteria led to the formulation of conceptual models that incorporate the effects of these activities. The conceptual models use parameter values as documented in CCA, Appendix DEL (DOE 1996), such as:

- drill collar diameter and length
- casing diameters
- drill pipe diameter
- speed of drill string rotation through the Salado Formation
- penetration rate through the Salado Formation
- instances of air drilling
- types of drilling fluids
- amounts of drilling fluids
- borehole depths
- borehole diameters
- borehole plugs

- fraction of each borehole that is plugged
- instances of encountering pressurized brine in the Castile Formation

The DBDSP data set includes the final borehole depth for wells drilled in the Delaware Basin. Borehole depths range from 19 feet to 25,201 feet. The 19-foot hole is an exhaust shaft monitoring well located on the WIPP Site, and the 25,201-foot hole is a gas well located in Texas. Borehole depths in the immediate vicinity of the WIPP Site typically range from 7,750 feet to 9,000 feet for oil wells and 13,000 feet to 16,000 feet for gas wells.

The diameter of each well bore is more difficult to ascertain. The DBDSP data set included the casing size and depth for each section of the hole drilled in the last year in the nine-township area (Table 1). Drill bit size is not a reportable element, although hole sizes are reported on Sundry notices (miscellaneous forms) maintained by the New Mexico Oil Conservation Division (NMOCD). The casing size or hole size is used to determine the size of the bit used to drill that particular section of the well. In previous years, the most common bit sizes were 17 1/2 inches for the surface section, 12 1/4 inches for the intermediate section, and 7 7/8 inches for the production section of the hole. This year this common pattern was observed. Table 2 shows the documented bit sizes used in drilling wells in the nine-township area during the past year. The typical hole and casing sizes, for a three-string well in the vicinity of the WIPP Site, are shown in Figure 2.

2.1.1 Drilling Techniques

The drilling techniques reported in CCA, Appendix DEL, CRA-2004, Appendix DATA, and CRA-2009, Appendix DATA are still being implemented by area drillers. There were 184 hydrocarbon wells spudded, not necessarily completed, in the New Mexico portion of the Delaware Basin from September 1, 2011 through August 31, 2012. This number is derived from the Delaware Basin Well Tracking Application (DBWTA) maintained by the DBDSP. In reality, the number of new wells is higher; but the paperwork on some of the wells has not yet been filed with the NMOCD or will be filed after this report is issued. Therefore, those wells are not included in the count listed above.

Rotary drilling rigs were used to drill the 184 wells. Some have been completed as oil wells, others as gas wells, while the rest are still in the process of being completed. The 184 wells were conventionally drilled utilizing mud as a medium for circulation. Sixteen of these wells were in the nine-township area. The depths of the completed wells in the nine-township area range from 8,241 feet to 16,526 feet. Outside of the nine-township area the depths of the completed wells range from 6,550 feet to 19,212 feet.

A technique used by operators to increase production is to drill a well horizontally after a target depth is reached, which allows for more of the wellbore area to be in the production zone. As reported in CCA, Appendix DEL, this technique is not often used in this area because of the increased costs due to the additional drilling time needed,

however in recent years there has been an increase in new wells in New Mexico that have been horizontally completed. The DBDSP monitors directional and horizontally drilled wells only in the nine-township area. Nine of the fifteen new wells spudded during the last year in the nine-township area had horizontally drilled components.

2.1.2 Drilling Fluids

Employing a rotary rig for drilling involves the use of drilling fluids. Drilling fluid, commonly known as mud, is the liquid circulated through the wellbore during rotary drilling and workover operations. In addition to its function of bringing cuttings to the surface, drilling mud cools and lubricates the bit and drill stem, protects against blowouts by holding back subsurface pressures, and deposits a mud cake on the wall of the borehole to prevent loss of fluids into the formation.

Typically, a driller will use fresh water and additives to drill the surface section of the borehole, which ends at the top of the Salado Formation. A change in drilling practices would necessitate a change in the application of drilling fluids. Within the KPLA of southeastern New Mexico, drillers are required under Title 19, Chapter 15, Order R-111-P of the New Mexico Administrative Code (NMAC) to use saturated brine to drill through the salt formation, which is usually called the intermediate section. This requirement is to keep the salt from washing out and making the hole larger than necessary. Once this section has been drilled and cased, the driller again changes to fresh water and additives to finish drilling the hole to depth.

2.1.3 Air Drilling

A method of hydrocarbon drilling not emphasized in CCA, Appendix DEL is air drilling. As defined by the oil industry, air drilling is a method of rotary drilling using compressed air as the circulation medium. The conventional method of removing cuttings from the wellbore is to use a flow of water or drilling mud. In some cases, compressed air removes the cuttings with equal or greater efficiency. The rate of penetration is usually increased considerably when air drilling is used; however, a fundamental problem in air drilling is the penetration of formations containing water, since the entry of water into the system reduces the ability of the air to remove cuttings. Air drilling occurrences are tracked by the DBDSP in the New Mexico portion of the Delaware Basin only.

Stakeholders noted the air drilling scenario was not included by the DOE in the CCA and raised several issues: (1) air drilling technology is currently successfully used in the Delaware Basin, (2) air drilling is thought to be a viable drilling technology under the hydrological and geological conditions at the WIPP Site, and (3) air drilling could result in releases of radionuclides that are substantially greater than those considered by the DOE in the CCA. Considerable research on air drilling in the Delaware Basin has determined that, although air drilling is a common method of drilling wells, it is not practiced in the vicinity of the WIPP Site because (1) it is against NMOC R-111-P regulations to drill with anything but saturated brine through the salt formation in the KPLA; (2) it is not economical to drill with air when a driller has to use saturated brine

for the intermediate section; and (3) if water is encountered prior to or after drilling the salt formation, the driller would have to convert to a conventional system of drilling.

DOE provided additional information to EPA Air Docket No. A-93-02, IV-G-7 (RK 1998). In this information, the following was provided:

The well record search has continued and now includes information from the entire New Mexico portion of the Delaware Basin. Within the nine-townships surrounding the WIPP, the records showed no evidence of air drilling. One possible exception to this may be the Lincoln Federal #1. This well is said to have been air drilled due to a loss of circulation at a depth of 1290 feet, but this has not been verified. The records associated with the Lincoln Federal #1 do not contain any evidence of air drilling. Rather, this information is based on verbal communications with the operating and drilling companies involved with the well. Nonetheless, the Lincoln Federal #1 may have been drilled with air, although it was not a systematic use of the technology. Air drilling at this well was used from 2984' to 4725' merely as a mitigative attempt to continue drilling to the next casing transition depth. After this casing transition, mud drilling was used for the remainder of the hole.

The area of the expanded search contains 3,756 boreholes. Of these, 407 well files were unavailable for viewing (in process); therefore, 3,349 well files constitute the database. Among these wells, 11 instances of air drilling were found in which any portion of the borehole was drilled with air. Only 7 of these were drilled through the Salado Formation at the depth of the repository. This results in a frequency of 7/3349, or 0.0021. This value is conservative in that it includes the Lincoln Federal #1, and four other wells which were proposed to be drilled with air, but no subsequent verification of actual drilling exists in the records.

In the CCA Final Rule (FR Vol. 63 No. 95) the EPA ruled air drilling did not have to be considered for PA; however, the DBDSP will continue to monitor for instances of air drilling (EPA 1998).

During the summer of 1999, another search of these same records was conducted as a follow up to the original research. This search of the records was used as a quality assurance check of the original search. The database consisted of 3,810 boreholes with only 12 records unavailable for viewing. This search added five more wells with indications of some portion of the borehole being drilled with air. None were located in the nine-township area or were air drilled through the Salado Formation. Of the five wells added to the count, one (the Sheep Draw "28" Federal #13) had the first 358 feet air drilled while the other four had the conductor pipe drilled with air which consists of the first 40 feet of the borehole and is not usually reported in the drilling process. The conductor casing is typically drilled, set in place, and cemented prior to setting up the rotary drilling rig that will eventually drill the well.

The records on the new wells spudded during the last year (September 1, 2011 through August 31, 2012) are being checked as they become available at the NMOCD Internet site for instances of air drilling. The records can be submitted to the NMOCD offices as late as two years after the well has been drilled. The record review is an ongoing process. None of the records reviewed to date have indicated any additional instances of air drilling. Air drilling is not a common practice in the vicinity of the WIPP Site. Table 3 shows the known indications of air drilling that have occurred in the New Mexico portion of the Delaware Basin.

2.2 Shallow Drilling Events

The criteria in 40 CFR Part 194.33 is that the CCA and subsequent CRAs must adequately and accurately characterize the frequency of shallow drilling within the Delaware Basin, as well as, support the assumptions and determinations, particularly those that limit consideration of shallow drilling events based on the presence of resources of similar type and quantity found in the controlled area. The EPA defined shallow drilling as “drilling events in the Delaware Basin that do not reach a depth of 2,150 feet below the surface relative to where such drilling occurred.” The DOE concluded in CCA, Appendix SCR that shallow drilling could be removed from PA consideration based on low consequence. As a result, the DOE did not include shallow drilling in its PA drilling rate calculations and did not include any reduction in shallow drilling rates during the active and passive institutional control periods. In CCA, Compliance Application Review Document (CARD) 33, the EPA accepted the DOE’s finding that shallow drilling would be of low consequence to repository performance and need not be included in the PA.

Although the EPA has agreed, in CARD 33, shallow drilling is of low consequence and could be eliminated from the PA, the DBDSP collects data on wells reported to be drilled within the boundaries of the Delaware Basin. Table 4 shows a breakdown of the various types and number of shallow wells located within the Delaware Basin. The shallow drilling rate can be calculated as follows: number of holes less than 2,150 ft drilled in the last 100 years times 10,000 years divided by the area of the Delaware Basin (23,102.1 square kilometers (km²)) divided by 100 years. As of August 31, 2012, there were 6,664 boreholes less than 2,150 feet. Applying the formula results in the following: 6,664 boreholes x 10,000 years / 23,102.1 km² / 100 years. This results in a shallow drilling rate for 2012 of 28.8 boreholes per km² over 10,000 years.

2.3 Deep Drilling Events

In accordance with the criteria, the DOE used the historical rate of drilling for resources in the Delaware Basin to calculate a future drilling rate. In particular, in calculating the frequency of future deep drilling, 40 CFR §194.33(b)(3)(i) (EPA 1996) provided the following criteria to the DOE:

Identify deep drilling that has occurred for each resource in the Delaware Basin over the past 100 years prior to the time at which a compliance application is prepared.

The DOE used the historical record of deep drilling for resources below 2,150 feet that has occurred over the past 100 years in the Delaware Basin. This was chosen because it is the depth of the repository, and the repository is not directly breached by boreholes less than this depth. In the past 100 years, deep drilling occurred for oil, gas, potash, and sulfur. These drilling events were used in calculating a rate for deep drilling for the PA as discussed in CCA, Appendix DEL. The period of calculation used was from January 1896 through June 1995. Historical drilling for purposes other than resource exploration and recovery (such as WIPP Site investigation) were excluded from the calculation in accordance with criteria provided in 40 CFR §194.33.

In the Delaware Basin, deep drilling events are usually associated with oil and gas drilling. Commercial sources and state regulating offices are used to identify these events. The DBDSP collects data on drilled wells within the Delaware Basin, making no distinction between resources. One combined Microsoft® SQL Server® based well tracking application is maintained on hydrocarbon wells for Texas and New Mexico. As information on wells is acquired, it is entered into this well tracking application. The Texas portion of the well tracking application contains information only on the current status of the well, when it was drilled, its location, the name of the operator, and the total depth of the well. The Texas portion is used only for calculating the drilling rate. The New Mexico portion contains the same basic information as Texas, along with the required features, events, and processes for PA-related drilling events.

The DBDSP continues to monitor hydrocarbon drilling activity and any new potash, sulfur, water, or monitoring wells for deep-drilling events. Information from the drilling of these wells is added to the well tracking application maintained for these resources. During the last year, there were 980 new wells added to the well tracking application. Most of the wells were drilled for hydrocarbon extraction and were deep-drilling events. Fifteen of these new wells are in the nine-township area immediately surrounding the WIPP Site. Table 5 shows the number and type of deep wells located in the Delaware Basin.

2.4 Past Drilling Rates

The EPA provided a formula for calculating the current drilling rate or intrusion rate when 40 CFR Part 194 was promulgated. The formula is as follows: number of holes drilled in the last 100 years times 10,000 years divided by the area of the Delaware Basin (23,102.1 km²) divided by 100 years (1897-1996, the year the CCA was submitted). The DBDSP uses deep drilling events of any resource (potash, oil, gas, water, etc.) to calculate the drilling or intrusion rate.

The drilling rates since the submittal of the CCA in 1996 are shown in Table 6. The large increase between 1996 and 1997 is the result of updating the databases with information

from June 1995 through August 1997. Also, the 100-year period is considered a moving period, in which 100 years worth of data are used each time the calculation is performed. As each new year's data are added, the oldest year's data are dropped. For example, the drilling rate was calculated in 1999 by using the data from 1900 through 1999. In 2000, the data from 1901 through 2000 were used to calculate the drilling rate.

2.5 Current Drilling Rate

The calculated deep drilling rate for 2012 was derived from the information provided in Table 5. There were 15,559 boreholes deeper than 2,150 feet. One well was removed from the count because it is no longer within the 100-year interval. This brings the total deep well count to 15,558 boreholes. Applying the formula results in the following: $15,558 \text{ boreholes} \times 10,000 \text{ years} / 23,102.1 \text{ km}^2 / 100 \text{ years}$. This results in a drilling rate of 67.3 boreholes per km^2 over 10,000 years.

This is an increase from the 46.8 boreholes per km^2 reported in the CCA. The deep drilling rate is anticipated to rise for several more years before it begins to drop. This is because of the 100-year moving time frame used for drilling results. As new wells are added to the count, wells older than 100 years are dropped. This year, the first well, spudded in 1911, was dropped from the count because it was older than 100 years. The next well won't be removed from the count, due to the 100-year time frame, until 2014. In the meantime, a number of new wells will continue to be added each year due to ongoing oil and gas drilling activity, thus increasing the rate.

2.5.1 Nine-Township Area Drilling Activities

From September 1, 2011 to August 31, 2012, there were sixteen new wells spudded in the nine-township area immediately surrounding the WIPP Site. Two new wells were drilled in the one-mile area surrounding the WIPP Site with one to the southwest and one to the southeast of the site. Figure 3 shows the status of known hydrocarbon wells drilled within the one-mile area of the WIPP Site. Of the sixteen new wells, eleven were drilled in Eddy County and five in Lea County. Three of the wells are to the north of the site, five are to the east, and eight are to the south of the WIPP Site.

2.5.2 Drilling Activities Outside the Nine-Township Area

In the New Mexico portion of the Delaware Basin outside of the nine-township area, there were 168 new wells spudded during the reporting period of September 1, 2011 through August 31, 2012. Of the 168 wells, 121 are located in Eddy County and 47 are in Lea County.

In the Texas portion of the Delaware Basin, 717 new wells were spudded during the reporting period. The DBDSP monitors drilling activities in portions of seven counties and all of one county (Loving). A majority of the wells were drilled in Loving, Reeves, Ward, and Culberson counties.

2.6 Castile Brine Encounters

The WIPP PA included the assumption that a borehole results in the establishment of a flow path between the repository and a pressurized brine pocket that might be located beneath the repository in the Castile Formation. Research was performed in an attempt to verify this assumption. Studies recorded a total of 27 out of 620 wells encountering pressurized brine in the Castile Formation; of these, 25 were hydrocarbon wells scattered over a wide area in the vicinity of the WIPP Site. The remaining wells, ERDA 6 and WIPP 12, were drilled in support of WIPP Site characterization.

As indicated earlier, the search of the records performed in 1999 for instances of air drilling also looked for instances of pressurized brine. Although the search of the records noted a number of instances of encounters with sulfur water and brine water, only the original 27 were found to have been pressurized brine encounters in the Castile Formation.

The DBDSP researches the well files of new wells drilled in the New Mexico portion of the Delaware Basin each year looking for instances of encounters with pressurized brine. The program also sends out an annual survey to operators of new wells asking if they encountered pressurized brine during the drilling process. As of this report, none of the records reviewed indicated encounters with pressurized brine during the drilling of new wells spudded in the New Mexico portion of the Delaware Basin between September 1, 2011 and August 31, 2012.

Seven wells drilled since the 1996 CCA have encountered Castile Brine. Six were identified when WIPP Site personnel performing field work talked to area drillers. The other encounter was reported by an operator in the Annual Survey of area drillers. The new encounters have been in areas where Castile Brine is expected to be encountered during the drilling process. Table 7 shows known Castile Brine encounters in the vicinity of the WIPP Site.

In the 1996 CCA, the probability for encountering a Castile Brine reservoir was calculated at 8 percent with 27 hits out of 345 possibilities. In the Performance Assessment Verification Test (PAVT), the EPA mandated a range of 1 percent to 60 percent. These higher values did not influence the predicted performance of the repository. The CRA-2004 continued to use the higher values and a probability for encountering a Castile Brine reservoir was not calculated. The CRA-2009 uses the values from the PAVT. However, due to the increased drilling in the area it was necessary to see if the original value was still valid. The same parameters were used and the rate was calculated at 5 percent with 34 brine encounters out of 678 possibilities. This is a reduction of 3 percent over the last eleven years.

2.7 Borehole Permeability Assessment - Plugging Practices

The hydrocarbon well plugging assumptions used for the borehole permeability assessment remain valid. The regulations in place during the submittal of the CCA, the

CRA-2004, and the CRA-2009 have not changed. The assessment will not change unless the regulations change to allow a different method of plugging. Regulations require the well be plugged in a manner that will permanently confine oil, gas, and water in the separate strata in which they were originally found. These regulations require a notice of intent to plug from the operator to the regulating agency. This notice includes a diagram of the well bore and the placement of the plugs. A 24-hour notice to the NMOCD or to the Bureau of Land Management (BLM) is required before plugging may commence.

Approximately 900 wells in the vicinity of the WIPP Site are in the KPLA. Under NMOCD R-111-P regulations, the operator is required to provide a solid cement plug through the salt section and any water-bearing horizon in addition to installing a bridge plug above the perforations. The above requirement provides protection to mineralized potash areas and workings by requiring a continuous plug so there is virtually no chance of flooding nearby mines either as they are developed or during their operation.

In the New Mexico portion of the Delaware Basin, the DBDSP retrieves a copy of the plugging report from the NMOCD Internet site when a well has been plugged and abandoned. This information is added to the records maintained by the DBDSP on each well drilled within the Delaware Basin. By maintaining records in such a fashion, should the regulations change and the plugging methods differ from what is now occurring, a trend would be noticed and the borehole permeability assessment revisited. Table 8 shows various plug information on the wells plugged and abandoned within the New Mexico portion of the Delaware Basin in the last year.

Compliance Certification Application, Appendix MASS, Attachment 16-1 describes the development of a conceptual model for long-term performance of plugged boreholes. The study did not attempt to predict the effectiveness of plugs, but to identify the location and physical characteristics of plugs, which might be important to performance assessment. Guidance in 40 CFR Part 194.33 states, "Performance assessments should assume that the permeability of sealed boreholes will be affected by natural processes, and should assume that the fraction of boreholes that will be sealed by man equals the fraction of boreholes which are currently sealed in the Delaware Basin." The criteria also state that "...drilling practices will remain as those of today." Only wells plugged in the New Mexico portion of the Delaware Basin were used for the study and only wells drilled after 1988, when the current plugging regulation went into effect, were used. The results of this study indicated the PA should assume a 100 percent plugging frequency.

To determine the typical configuration and composition of a borehole plug, the study considered plugging practices to arrive at a model depicting six different types of plugging configurations (see Figure 4):

Type I Plugs will be located at the transition between the surface and intermediate casings and the transition between the intermediate and production casings. This area is usually the top of the Salado Formation and the bottom of the Castile Formation, roughly 800 feet and 4,000 feet below the surface, respectively.

- Type II This plugging configuration has a portion of the production casing salvaged. Where the production casing was cut, a plug must be installed. If a plug occurs between 2,150 feet and 2,700 feet (above the hypothetical brine pocket) and the other plugs occur at the top of the Salado Formation and below the Castile Formation, it is considered a Type II configuration.
- Type III This configuration is the same as above except the removed production casing plug occurs above 2,150 feet.
- Type IV Extra plugs, in addition to those of Type II, have been emplaced above 2,150 feet.
- Type V The minimum regulatory requirements require a surface plug and a plug occurring at the bottom, provided no water-bearing zones were encountered. This type of plugging configuration is not common.
- Type VI This configuration has a solid cement plug through a significant portion of the salt section. This configuration, like the others, may have additional plugs above and below the salt-section plug.

There were 25 wells plugged during the reporting period. Four wells are in the nine-township area and 21 are outside the nine-township area. Three of the 25 wells are in the KPLA. Two wells have total depth of less than 300 feet. These two wells will not be considered in the permeability assessment update. Therefore, 23 of the 25 wells will be used in the permeability assessment update (see Table 9 and Table 10).

2.8 Seismic Activity in the Delaware Basin

Known seismic events occurring in Southeast New Mexico and West Texas, specifically in the Delaware Basin, are recorded in a database and on a map. This information is obtained every quarter in a report from the New Mexico Institute of Mining and Technology, Socorro, New Mexico, utilizing data from an array of nine seismographs in the vicinity of the WIPP Site (NMIMT 2012).

During the reporting period there were five seismic events recorded in the Delaware Basin. Two seismic events occurred in Reeves County with magnitudes of 1.5 and 2.0. Three seismic events occurred in Eddy County with magnitudes of 1.2, 1.6, and 2.4. One seismic event in Eddy County which occurred on 3/18/2012 with a magnitude of 2.4 can be attributed to a mine collapse. Table 11 provides information on recorded seismic events, which have occurred in the Delaware Basin.

2.9 Secondary and Tertiary Recovery

Secondary recovery is defined by the oil industry as the first improved recovery method of any type applied to a reservoir to produce oil not recoverable by primary recovery

methods. Waterflooding is one such method. This method involves pumping water through the existing perforations in a well. As the water is pumped into a formation, it stimulates production of oil or gas in other nearby wells. This is a proven method of recovering hydrocarbons. Waterflooding has been a popular form of secondary recovery for over 40 years. Waterflooding can be accomplished by one injection well or several injection wells in the immediate vicinity of other producing wells.

In the New Mexico portion of the Delaware Basin, there are three major waterflood projects and several one and two injection well operations. One of the major waterflood projects in the area is the El Mar, located in T26S-R32E, on the Texas border. At one time, this project had 31 permitted injection wells. Currently, there are three injection wells actively injecting water. The remaining wells are either shut-in, temporarily abandoned, or plugged and abandoned. The Paduca waterflood project, located in T25S-R32E, has six permitted injection wells with five injecting water into the formation. The third major waterflood project in this area is the Indian Draw, located in T22S-R28E, has nine permitted injection wells and is currently injecting into six of its permitted wells.

Tertiary recovery is defined by the oil industry as the use of any improved recovery method to remove additional oil after secondary recovery. At the time of this report, there are no known tertiary recovery projects being operated in the vicinity of the WIPP Site, although several projects are being operated by oil companies in the Texas portion of the Delaware Basin using CO₂.

2.9.1 Nine-Township Injection Wells

Secondary recovery projects occurring in the nine-township area are on a small scale. There are six injection wells located in the nine-township area surrounding the WIPP Site. *ConocoPhillips Company* operates two injection wells northwest of the site in the Cabin Lake field. The other four injection wells are operated by *OXY USA INC* and are located south and east of the site. The six wells are injecting into the Brushy Canyon Formation of the Delaware Mountain Group at a depth of approximately 7,200 feet. Figure 5 shows a typical injection or salt water disposal well configuration. Table 12 provides information on the injection wells located in the nine-township area.

2.9.2 Nine-Township Salt Water Disposal Wells

The most common type of injection well is for the disposal of brine water coming from the producing formation in oil and gas wells. Figure 6 shows the location of active injection and salt water disposal wells in the nine-township area. Most producing oil and gas wells produce water along with oil or gas. Salt Water Disposal (SWD) wells have become necessary as a result of the EPA's ruling that formation water may no longer be disposed of on the surface. The oil companies now dispose of this water by injecting it into approved SWD wells.

There are currently fifty-five SWD wells located in the nine-township area surrounding the WIPP Site. Three operators, *Devon Energy Production Company, LP*, *OXY USA*

INC, and *Yates Petroleum Corporation*, operate the majority of the SWD wells. Injection depths range from 3,400 feet to 8,500 feet. During the last year, based on injection records, the three companies operated within their maximum permitted injection pressure. The volume of disposed brine water depends on the number of producing oil and gas wells maintained by the operator in the immediate vicinity of the SWD well. Table 12 provides information on SWD and injection wells in the nine-township area.

2.10 Mining

Resources found in the Delaware Basin that can be mined are potash, sulfur, caliche, gypsum, and halite (NMBMMR 1995).

2.10.1 Potash Mining

Potash mining in the immediate vicinity of the WIPP Site continues as reported in CCA, Appendix DEL and CRA-2004, Appendix DATA. Figure 7 shows the location and the extent of the potash mines in the vicinity of the WIPP Site. There have been several changes to the companies that operate in the area, most notably, only two potash companies are actively mining. No plans have been promulgated by either company to sink new shafts or develop new mines; however, a new company, *Intercontinental Potash*, has procured leases to the east of the WIPP site and proposes to develop two separate underground mines in order to mine polyhalite (a type of potash).

In August 1996, *Mississippi Potash* (a subsidiary of *Mississippi Chemical Corporation*) purchased the assets of *New Mexico Potash Corporation* and *Eddy Potash, Inc.* These plants were renamed Mississippi East and Mississippi North, respectively. In early 2004, *Mississippi Potash* sold its Carlsbad properties to *Intrepid Mining LLC*, a Denver based mining company. Recently the company changed the name to *Intrepid Potash – New Mexico, LLC*. The former *Eddy Potash, Inc.* mine (Mississippi North) is currently shut down.

The other potash producer in the area is *The Mosaic Company*, formerly known as *IMC Kalium Potash*, which was a wholly-owned subsidiary of *IMC Global*. *Western Ag-Minerals* was purchased by *IMC Global* in September 1997. This acquisition doubled the potash reserves for *IMC Kalium*. *IMC Global* merged with *Freeport-McMoRan*, a major world potash producer, in December 1997 with *IMC Global* as the surviving entity in the transaction. In 2004, *IMC Global* and *Cargill, Inc.* merged to form *The Mosaic Company*.

2.10.2 Sulfur Extraction

The only sulfur mining activity within the Delaware Basin was conducted by *Freeport-McMoRan Sulphur, Inc.*, formerly operated by *Pennzoil Sulphur Company*. The mine is located in Culberson County, Texas. The mine recovered sulfur utilizing the Frasch process, which consists of a hole drilled into the sulfur bearing formation and then cased. The next step involves the placement of three concentric pipes within the protective

casing to facilitate pumping superheated water down the hole, melting the sulfur, then using compressed air to lift the molten sulfur to the surface. The mine was operated until it permanently ceased production on June 30, 1999. Abandonment and salvage operations continued until early summer of 2000.

2.10.3 Solution Mining

Solution mining is the process by which water is injected into a mineral formation, circulated to dissolve the mineral, with the solution then pumped back to the surface where the minerals are removed from the water, usually by evaporation. There are several brine mines or wells in the area, two in New Mexico and ten in Texas (see Figure 8), that use this process to provide a brine solution for area drilling operators to use in the drilling process. These are shallow wells using injected fresh water to dissolve salt into a brine solution.

Brine wells are classified as Class II injection wells. In the Delaware Basin, the process involves injecting fresh water into a salt formation to create a saturated brine solution, which is then extracted and used as a drilling agent when drilling a new well. These wells are tracked by the DBDSP on a continuing basis. Table 13 provides the status of brine wells in the Delaware Basin.

A moratorium on new brine wells was enacted by the NMOCD in mid November 2008 due to the collapse of two brine wells in the vicinity of Loco Hills, New Mexico, neither of which is located in the Delaware Basin. One was in an isolated area and was actively producing brine for sale. This well collapsed in July 2008. The second well to collapse was located just outside of Loco Hills and had been recently plugged and abandoned. This well collapsed in early November 2008.

A brine well is closely being monitored by the NMOCD as it fits the geological profile of the two collapsed wells. This well is located within the Carlsbad city limits and is within the New Mexico portion of the Delaware Basin. It was voluntarily plugged and abandoned by the operator in October 2008.

In early 1997, *Mississippi Potash* proposed to set up a pilot potash solution mining project at the former *Eddy Potash, Inc.* mine located north of the WIPP Site and outside of the Delaware Basin. The BLM was provided with the necessary documentation to acquire a permit to operate the pilot project, but the project was postponed. In March 2002, *Mississippi Potash* again applied for a permit to operate a pilot in-situ potash solution mining project. In May 2002, the project was given approval to proceed by the BLM. *Intrepid Potash*, formerly *Mississippi Potash*, has continued with the project by developing a required Environmental Impact Statement (EIS), which was approved by the BLM on March 19, 2012. Construction is occurring to install pipelines, wells, and evaporation ponds. The in-situ solution mining process will occur at the former *Eddy Potash, Inc.* mine, which is outside of the Delaware Basin however the evaporation ponds used to collect the potash are located just inside of the Delaware Basin.

In the late 1960s, *Conoco Minerals* installed a pilot solution mining project on leases it held on the former *AMAX* property north of the Delaware Basin and the WIPP Site. The project was designed to test solution mining of potassium minerals and consisted of one injection well and three withdrawal wells, but the potash ore zone was deemed too thin to make this method viable at this location.

2.11 New Drilling Technology

New drilling methods are researched by the DBDSP for impacts to the drilling methods currently used in the area. Recently, the NMOCD issued a new pit rule 19.15.17 NMAC, consequently most operators are now using the closed-loop system to drill wells on state land.

2.12 Alternative Energy Activities

The DBDSP researches alternative energy activities that may have impact on PA such as compressed air storage from wind farm activities. Alternative energy activities that may be conducted in the Delaware Basin include solar, wind, and geothermal power. Currently there are no known geothermal power projects being performed in the Delaware Basin. Solar power is currently being pursued in the Delaware Basin. *Sun Edison* completed construction of a new photovoltaic solar power plant on the southern edge of the Carlsbad city limits, which is located within the Delaware Basin. Wind power is a proven technology and has been ongoing in the Delaware Basin since 1995. Two wind farms operated by *FPL Energy* are located in the western mountains of the Delaware Basin. One farm operates approximately 140 turbines and the second one has 40 turbines. Both are located adjacent to each other approximately 10 miles south of the Guadalupe Mountains National Park and 75 miles southwest of the WIPP Site. The DBDSP will continue to monitor alternative energy activities.

3.0 Survey of Well Operators for Drilling Information

The DBDSP surveys local well operators annually to acquire information on drilling practices normally not available on the Sundry notices supplied to the local state and federal offices by the operator or through commercial sources maintained by the DBDSP. Participation in the survey is voluntary. This survey requests information on other items of interest to the WIPP Project such as hydrogen sulfide (H₂S) encounters, Castile Brine encounters, or whether any section of the well was drilled with air. The DBDSP personnel review the records on new wells drilled to look for the above data. The survey provides an additional source of information on drilling activities in the New Mexico portion of the Delaware Basin.

The first survey of area operators was performed July 1999 and had been sent out each July until 2004. An annual survey was not performed in July 2004. The survey for 2004 was moved to January 2005 and is performed in January of each year. With this change, results from the annual survey will be included in the annual report for that year as there

will be nine months for surveys to be returned instead of two months. As of this report, no return correspondence has been received from local well operators.

4.0 Summary - 2012 Delaware Basin Drilling Surveillance Program

- No new instances of air drilling.
- No Castile Brine encounters reported.
- The drilling rate has increased to 67.3 boreholes per square kilometer.
- No change in injection and salt water disposal activities.
- Sixteen wells spudded in the nine-township area.
- One hundred sixty-eight wells spudded outside the nine-township area in New Mexico.
- Seven hundred seventeen wells spudded in the Texas portion of the Delaware Basin.

5.0 References

- Kirkes, G. Ross, *Current Drilling Practices Near WIPP*, 1998, EPA Air Docket No. A-93-02, IV-G-7, January 22, 1998
- New Mexico Bureau of Mines and Mineral Resources (NMBMMR), 1995, *Evaluation of Mineral Resources at the Waste Isolation Pilot Plant*, Final Report, Vols. I-IV
- New Mexico Institute of Mining and Technology (NMIMT), 2011, *Seismicity of the WIPP Site for the Period July 1, 2011 through September 30, 2011*, Socorro, New Mexico
- New Mexico Institute of Mining and Technology (NMIMT), 2012, *Seismicity of the WIPP Site for the Period October 1, 2011 through December 31, 2011*, Socorro, New Mexico
- New Mexico Institute of Mining and Technology (NMIMT), 2012, *Seismicity of the WIPP Site for the Period January 1, 2012 through March 31, 2012*, Socorro, New Mexico
- New Mexico Institute of Mining and Technology (NMIMT), 2012, *Seismicity of the WIPP Site for the Period April 1, 2012 through June 30, 2012*, Socorro, New Mexico
- U.S. Department of Energy (DOE), 2011, DOE/WIPP-11-2308, *Delaware Basin Monitoring Annual Report*, September 2011
- U.S. Department of Energy (DOE), 1996, DOE/CAO-1996-2184, *Title 40 CFR Part 191 Compliance Certification Application for the Waste Isolation Pilot Plant*, October 1996
- U.S. Department of Energy (DOE), 2004, DOE/WIPP 2004-3231, *Title 40 CFR Part 191 Compliance Recertification Application for the Waste Isolation Pilot Plant*, March 2004
- U.S. Department of Energy (DOE), 2009, DOE/WIPP 2009-3424, *Title 40 CFR Part 191 Compliance Recertification Application for the Waste Isolation Pilot Plant*, March 2009
- U.S. Environmental Protection Agency (EPA), 1996, *Title 40 CFR Part 194, Criteria for the Certification and Re-Certification of the Waste Isolation Pilot Plant's Compliance with the 40 CFR Part 191 Disposal Regulations*
- U.S. Environmental Protection Agency (EPA), 1998, *Title 40 CFR Part 194, Criteria for the Certification and Recertification of the Waste Isolation Pilot Plant's Compliance with the Disposal Regulations: Certification Decision; Final Rule*
- Washington TRU Solutions LLC, 2008, WP 02-PC.02, Rev. 4, *Delaware Basin Drilling Surveillance Plan*, May 2012

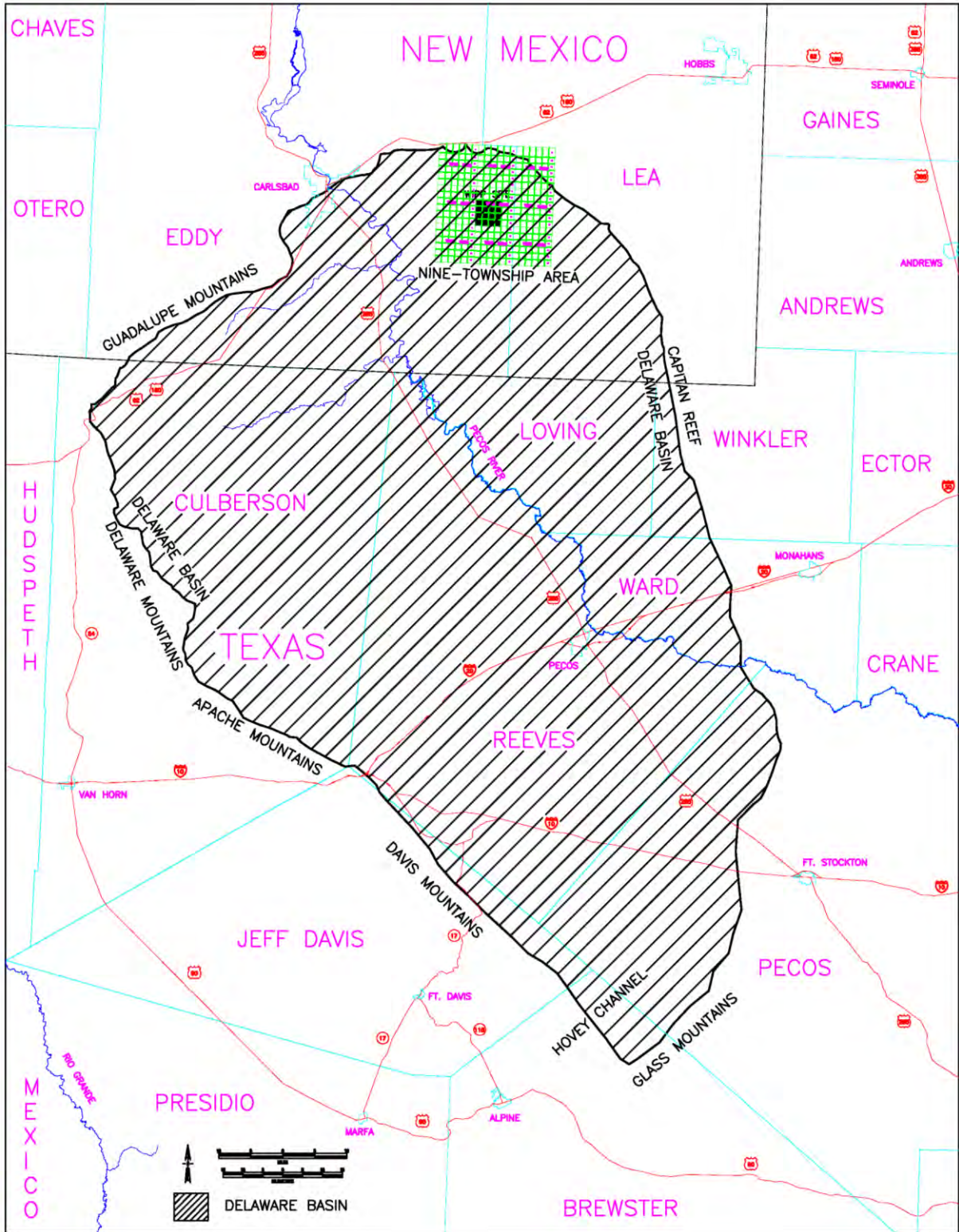

Figure 1: WIPP Site, Delaware Basin, and Surrounding Area

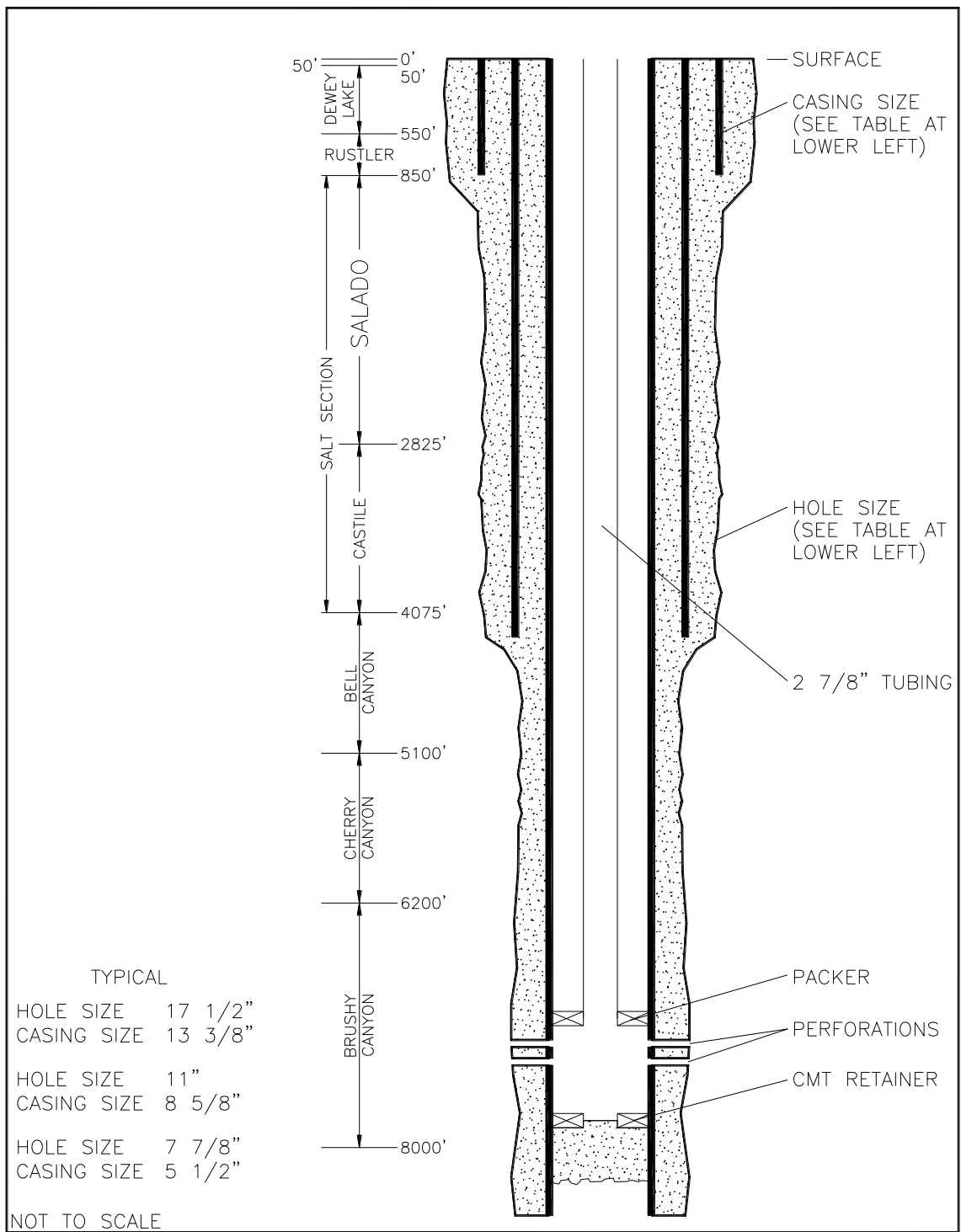

Figure 2: Typical Well Structure and General Stratigraphy Near the WIPP Site

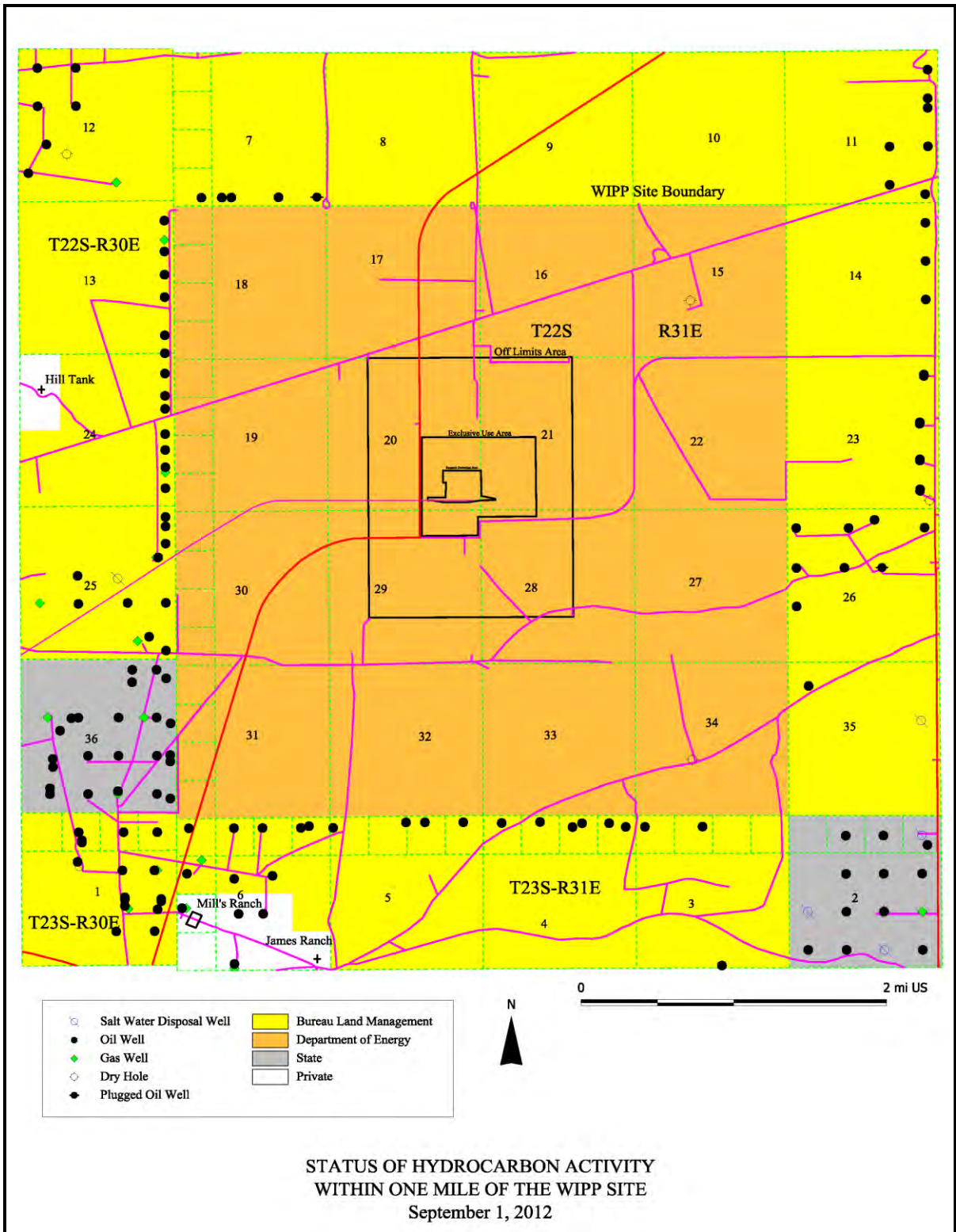

Figure 3: Oil and Gas Wells within One Mile of the WIPP Site

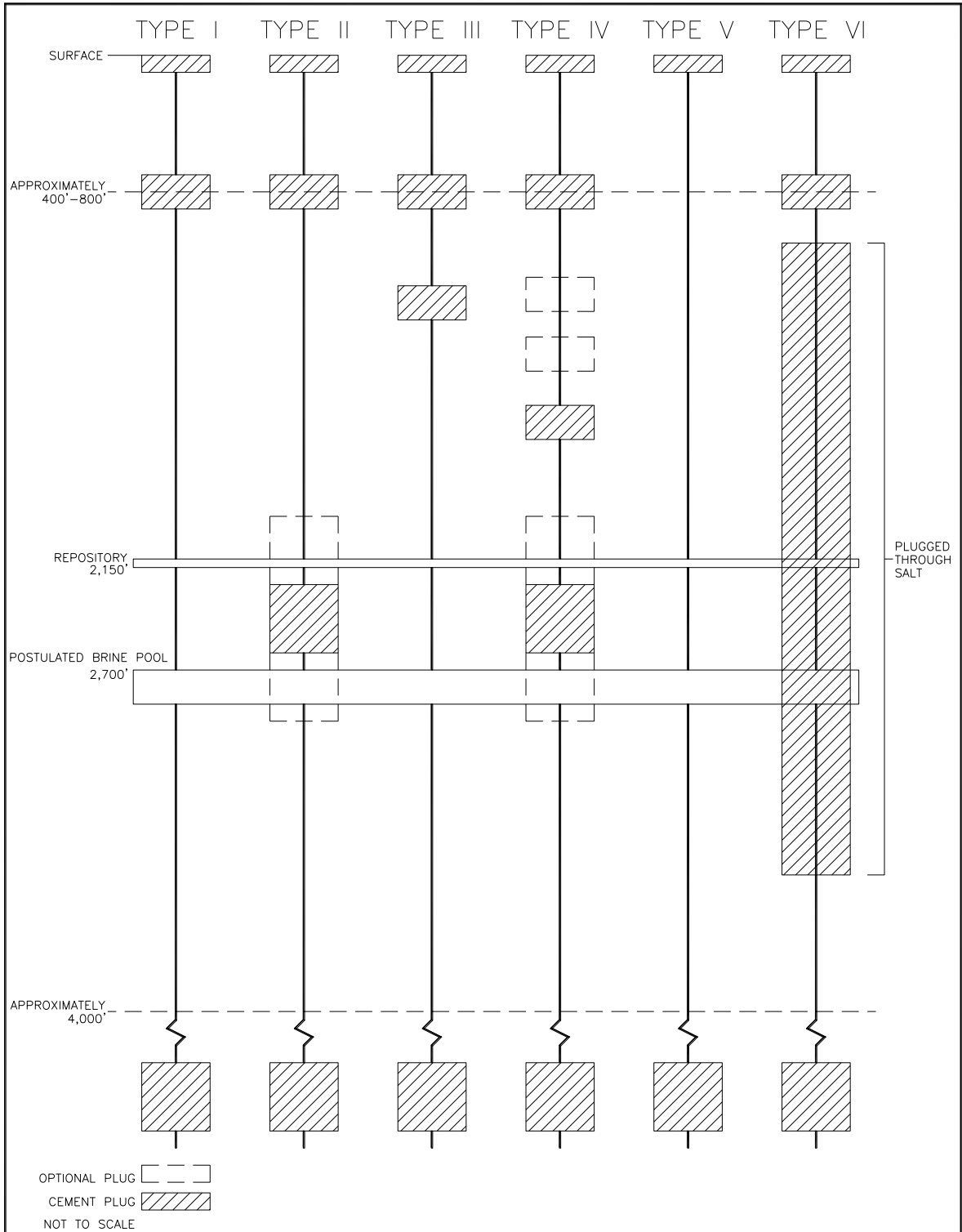

Figure 4: Typical Borehole Plug Configurations in the Delaware Basin

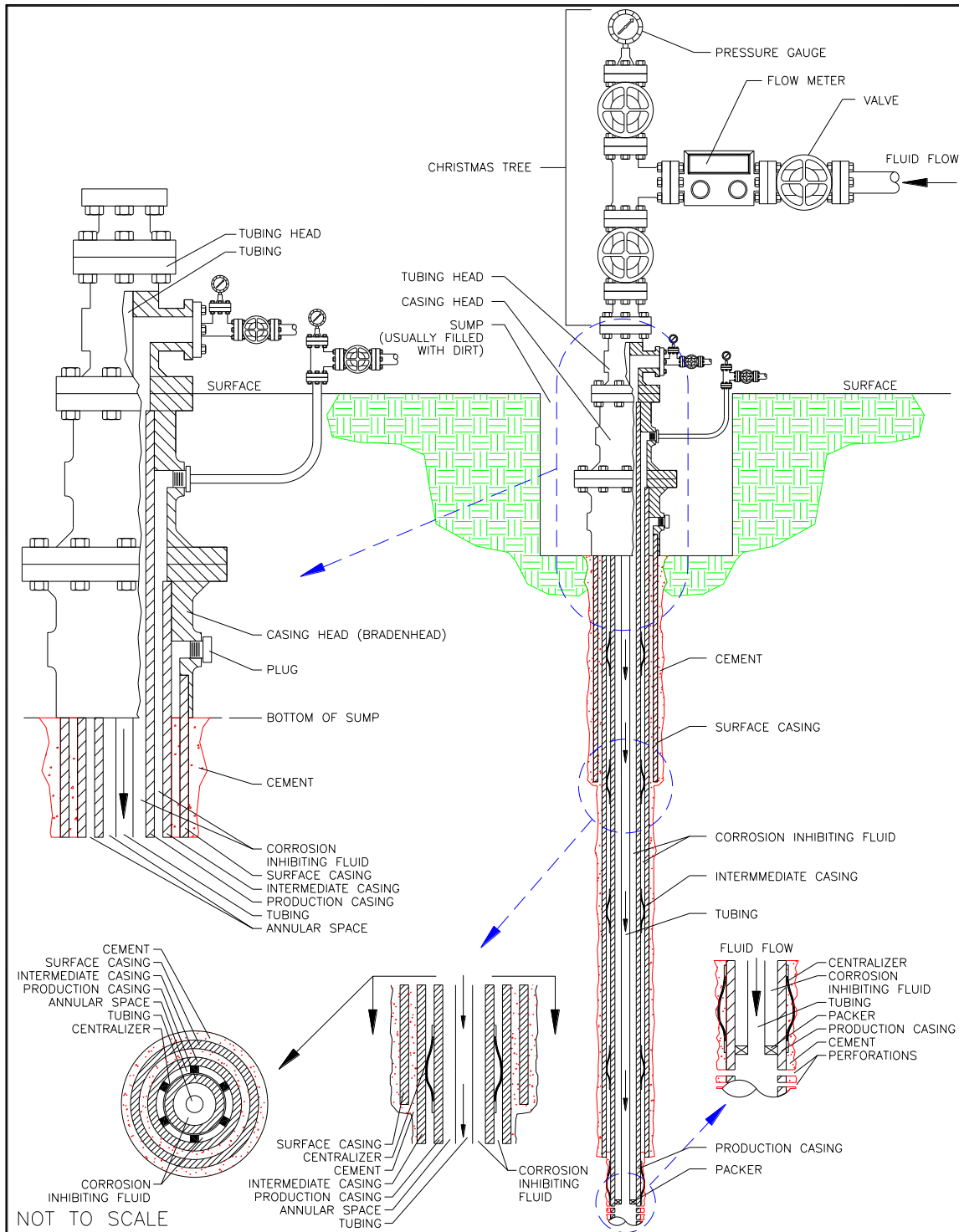

Figure 5: Typical Injection or Salt Water Disposal Well (SWD)

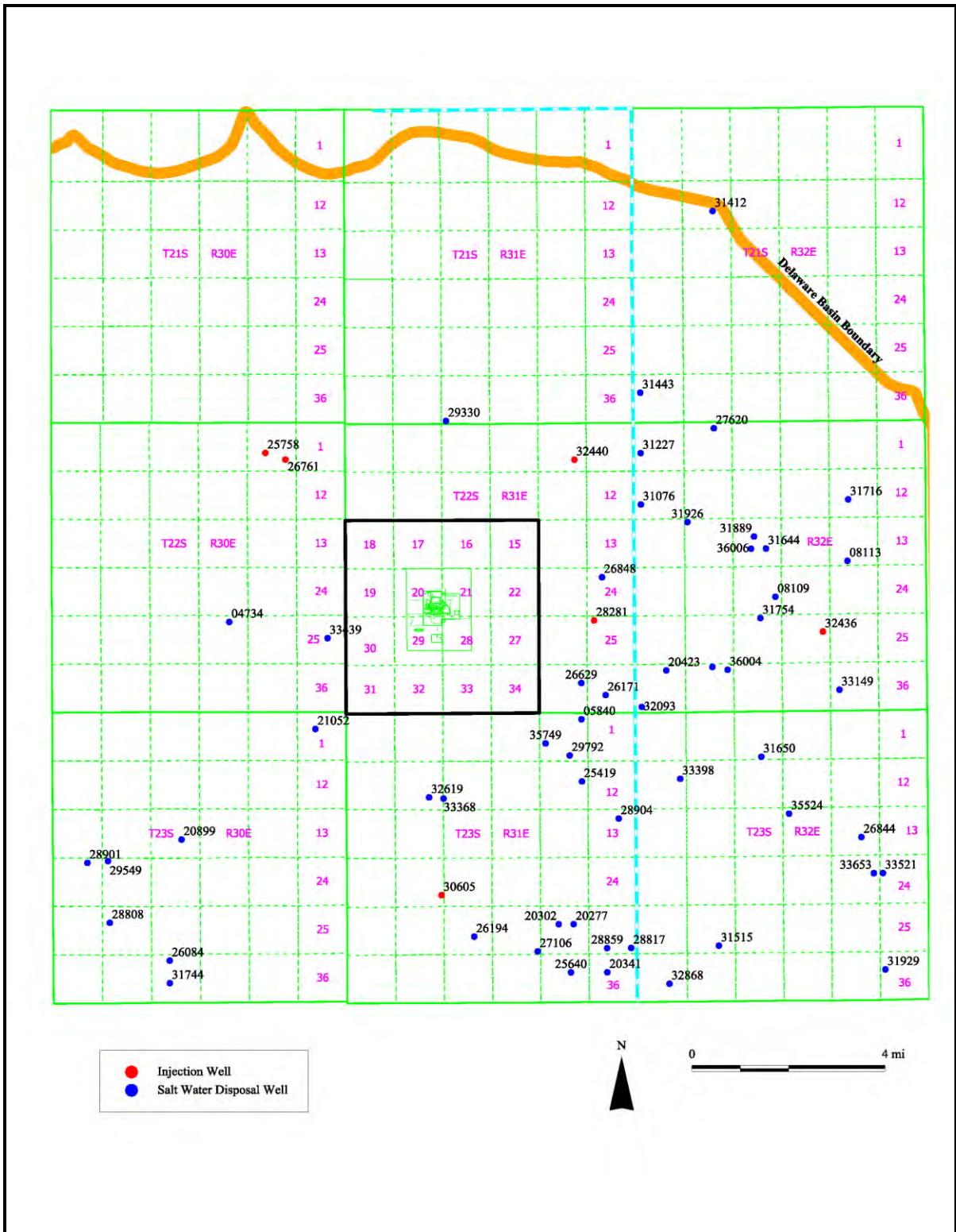

Figure 6: Active Injection and SWD Wells in the Nine-Township Area

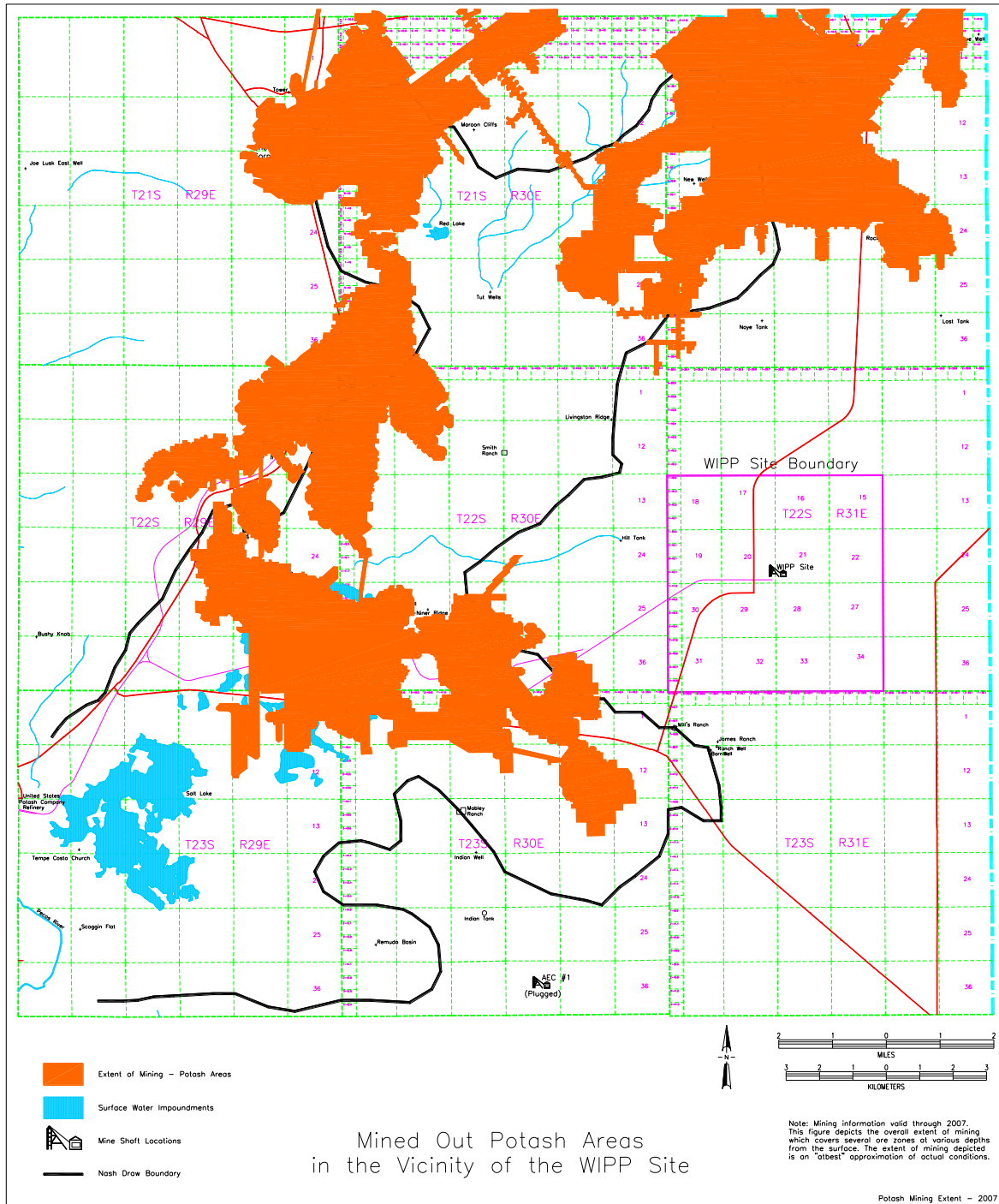

Figure 7: Potash Mining in the Vicinity of the WIPP Site

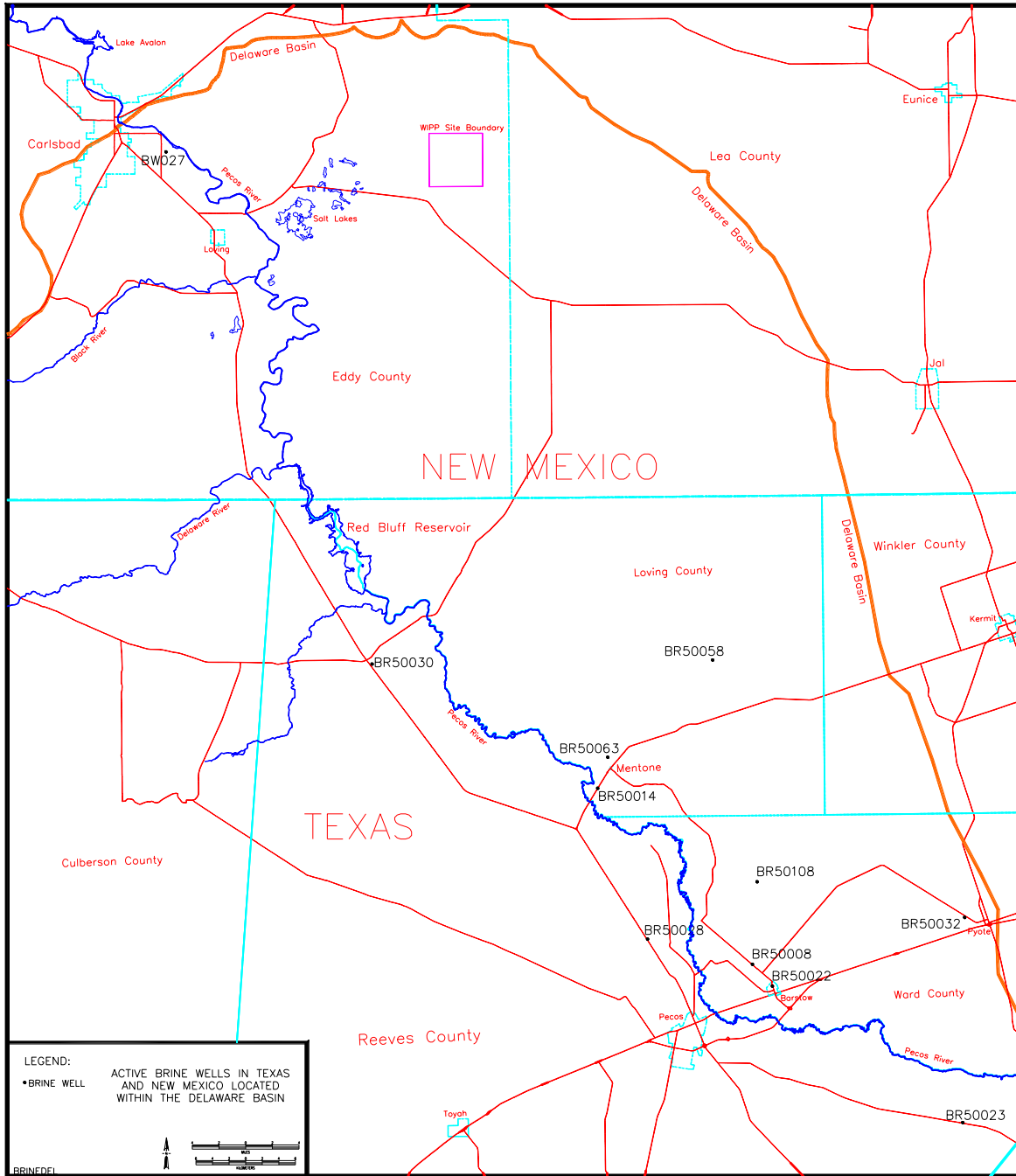

Figure 8: Active Brine Well Locations in the Delaware Basin

Table 1: Nine-Township Area Casing Sizes

Casing Size	Surface Casing	Intermediate Casing	Production Casing
16"	0	0	0
13 3/8"	6	0	0
11 3/4"	5	0	0
10 3/4"	0	0	0
9 5/8"	0	6	0
8 5/8"	0	5	0
7 5/8"	0	0	0
7"	0	0	2
5 1/2"	0	0	9

NOTE: There were sixteen wells drilled in the nine-township area between September 1, 2011 and August 31, 2012. Eleven of the wells had complete records available on casing sizes. The other wells had partial records available or had just recently been spudded.

Table 2: Nine-Township Area Bit Sizes

Bit Size	Surface Hole	Intermediate Hole	Production Hole
20"	0	0	0
17 1/2"	6	0	0
14 3/4"	5	0	0
13 3/8"	0	0	0
12 3/4"	0	0	0
12 1/4"	0	6	0
11"	0	0	0
10 5/8"	0	5	0
9 7/8"	0	0	0
8 3/4"	0	0	4
8 1/2"	0	0	1
7 7/8"	0	0	6
7 3/4"	0	0	0
7"	0	0	0
6 1/8 "	0	0	0

NOTE: Of the sixteen wells drilled in the nine-township area, complete records were available on eleven wells.

Table 3: Air-Drilled Wells in the New Mexico Portion of the Delaware Basin

#	Location	Well Name and No.	Spud Date	Status	Well Information
1	21S-28E-33	Richardson & Bass #1	7/27/1961	P&A	Air drilled through the salt. Between 2,545' and 2,685' encountered water and changed from air to mud-based drilling.
2	21S-32E-26	Lincoln Federal Unit #1	4/1/1991	P&A	Lost circulation at 1,290'. Hole was dry drilled to 1,792'. Supposedly, air drilled from 2,984' to 4,725'
3	23S-26E-17	Exxon "17" Federal #1	8/1/1989	Gas Well	Air drilled through the salt from 575' to 2,707'.
4	23S-28E-11	CP Pardue #1	10/28/1958	P&A	Air drilled through the salt from 390' to 2,620'
5	23S-28E-11	Amoco Federal #1	8/4/1979	Oil Well	Air drilled from 475' to 9,700'.
6	23S-28E-11	Amoco Federal #3	2/28/1980	Oil Well	Air drilled from 6,271' to 9,692'.
7	23S-28E-23	South Culebra Bluff Unit #3	1/21/1979	Oil Well	Air drilled from 6,345' to 8,000'.
8	23S-28E-23	South Culebra Bluff Unit #4	8/9/1979	Oil Well	Air drilled from 450' to 9,802'.
9	24S-31E-03	Lilly "ALY" Federal #2	5/1/1994	Oil Well	Air drilled conductor hole to 40'.
10	24S-31E-03	Lilly "ALY" Federal #4	5/16/1994	Oil Well	Air drilled conductor hole to 40'.
11	24S-34E-04	Antelope Ridge Unit #2	9/13/1962	Gas Well	Attempted to drill with gas. Had to convert to water at 1,035'. Tried again several times at different depths.
12	24S-34E-09	Federal "9" Com #1	12/3/1963	Gas Well	Hit water while gas drilling at 4,865'.
13	24S-34E-13	Federal Johnson #1	6/23/1958	P&A	Proposed to drill with air, but no information in the records indicate air drilling.
14	26S-32E-20	Russell Federal #1	3/16/1966	Oil Well	Drilled with air to 1,330'.
15	26S-32E-36	North El Mar Unit #44	2/19/1959	Oil Well	Proposed to drill with air, but no information in the records indicate air drilling.
Wells Drilled after Supplemental Information Provided to the EPA Docket in 1997.					
16	22S-26E-28	Sheep Draw "28" Federal #13	7/1/1997	Oil Well	Air drilled the first 358'.

Table 4: Shallow Well Status in the Delaware Basin

Well Type	Texas	New Mexico	Totals
Core Hole	31	2	33
Dry Hole	348	152	500
Gas Well	9	9	18
Injection Well	5	1	6
Junked and Abandoned Well	65	31	96
Oil Well	104	36	140
Oil and Gas Well	2	0	2
Plugged Gas Well	1	4	5
Plugged Oil Well	19	19	38
Plugged Brine Well	2	3	5
Plugged Salt Water Disposal Well	0	5	5
Drilling or Waiting on Paperwork	523	85	608
Brine Well	1	2	3
Salt Water Disposal Well	0	3	3
Service Well	12	0	12
Stratigraphic Test Hole	1,170	0	1,170
Sulfur Core Hole	502	0	502
Potash Core Hole	0	971	971
Water Well	1,706	590	2,296
WIPP Well	0	207	207
Other (Mine Shafts, Gnome Project Wells)	0	44	44
TOTALS	4,500	2,164	6,664

NOTE: Only the known holes that occur in the Delaware Basin are listed in the above table. The 608 wells under the listing of "Drilling or Waiting on Paperwork" do not have an associated depth until one has been reported on paperwork. These are listed as shallow wells but may eventually be placed in the deep classification when a depth has been listed in the paperwork.

Table 5: Deep Well Status in the Delaware Basin

Well Type	Texas	New Mexico	Totals
Core Hole	5	0	5
Dry Hole	2,189	812	3,001
Gas Well	1,129	925	2,054
Injection Well	298	57	355
Junked and Abandoned Well	55	19	74
Oil Well	4,723	2,735	7,458
Oil and Gas Well	125	4	129
Plugged Gas Well	257	196	453
Plugged Injection Well	59	55	114
Plugged Oil Well	850	479	1,329
Plugged Oil and Gas Well	44	0	44
Plugged Brine Well	0	1	1
Plugged Salt Water Disposal Well	4	30	34
Plugged Service Well	6	1	7
Drilling or Waiting on Paperwork	24	5	29
Brine Well	9	0	9
Salt Water Disposal Well	54	173	227
Service Well	69	0	69
Stratigraphic Test Hole	44	2	46
Sulfur Core Hole	85	0	85
Potash Core Hole	0	19	19
WIPP Well	0	11	11
Other (Mine Shafts, Gnome Project Wells)	0	6	6
TOTALS	10,029	5,530	15,559

NOTE: The 29 wells under the category of “Drilling or Waiting on Paperwork” have a depth associated with them which classifies them as deep wells, but the paperwork classifying these wells as oil, gas, or some other type of well have yet to be posted. When posted, the classification of these types of wells will be changed.

Table 6: Drilling Rates for the Delaware Basin

Year	No. of Deep Holes	Drilling Rate
1996	10,804 Holes Deeper Than 2,150 ft.	46.8
1997	11,444 Holes Deeper Than 2,150 ft.	49.5
1998	11,616 Holes Deeper Than 2,150 ft.	50.3
1999	11,684 Holes Deeper Than 2,150 ft.	50.6
2000	11,828 Holes Deeper Than 2,150 ft.	51.2
2001	12,056 Holes Deeper Than 2,150 ft.	52.2
2002 ¹	12,139 Holes Deeper Than 2,150 ft.	52.5
2003	12,316 Holes Deeper Than 2,150 ft.	53.3
2004	12,531 Holes Deeper Than 2,150 ft.	54.2
2005	12,819 Holes Deeper Than 2,150 ft.	55.5
2006	13,171 Holes Deeper Than 2,150 ft.	57.0
2007	13,520 Holes Deeper Than 2,150 ft.	58.5
2008	13,824 Holes Deeper Than 2,150 ft.	59.8
2009	14,173 Holes Deeper Than 2,150 ft.	61.3
2010	14,403 Holes Deeper Than 2,150 ft.	62.3
2011	14,816 Holes Deeper Than 2,150 ft.	64.1
Current	15,558 Holes Deeper Than 2,150 ft.	67.3

NOTE: The notable increase in the drilling rate between 1996 and 1997 was not due to the drilling of wells, but to the fact that the Delaware Basin Drilling Surveillance Program did not begin until 1997 when a review of the records from July 1995 through 1997 was necessary to bring the databases up to date. Since that time, the drilling rate has increased approximately the same each year.

¹ In Rev. 3 of this report dated September 2002, the drilling rate for 2002 was shown as 52.9 with 12,219 deep holes. While reviewing the databases to develop reports for the Compliance Recertification Application, it was noticed that 80 shallow wells in Texas were listed as being deep. Several days' investigation found the problem, which was corrected. Correcting the classification of the 80 holes to shallow resulted in a reduction in the drilling rate from 52.9 to 52.5. This was reported in December 2002.

Table 7: Castile Brine Encounters in the Vicinity of the WIPP Site

#	Location	Well Name and No.	Spud Date	Status	Well Information
Original CCA-related Castile Brine Encounters - 1896 Through June 1995					
1	21S-31E-26	Federal #1	10/31/1979	P&A	Identified as encountering Castile Brine.
2	21S-31E-35	ERDA-6	6/13/1975	P&A	Identified as encountering Castile Brine.
3	21S-31E-35	Federal "FT" #1	9/25/1981	P&A	Identified as encountering Castile Brine.
4	21S-31E-36	Lost Tank "AIS" State #1	12/7/1991	Oil Well	Identified as encountering Castile Brine.
5	21S-31E-36	Lost Tank "AIS" State #4	11/19/1991	Oil Well	Identified as encountering Castile Brine.
6	21S-32E-31	Lost Tank SWD #1	11/12/1991	SWD	Identified as encountering Castile Brine.
7	22S-29E-09	Danford Permit #1	5/18/1937	P&A	Identified as encountering Castile Brine.
8	22S-31E-01	Unocal "AHU" Federal #1	4/2/1991	Oil Well	Identified as encountering Castile Brine.
9	22S-31E-01	Molly State #1	9/25/1991	Oil Well	Identified as encountering Castile Brine.
10	22S-31E-01	Molly State #3	10/20/1991	Oil Well	Identified as encountering Castile Brine.
11	22S-31E-02	State "2" #3	11/28/1991	Oil Well	Identified as encountering Castile Brine.
12	22S-31E-11	Martha "AIK" Federal #3	5/6/1991	Oil Well	Identified as encountering Castile Brine.
13	22S-31E-11	Martha "AIK" Federal #4	9/2/1991	Oil Well	Identified as encountering Castile Brine.
14	22S-31E-12	Federal "12" #8	3/28/1992	Oil Well	Identified as encountering Castile Brine.
15	22S-31E-13	Neff "13" Federal #5	2/4/1991	Oil Well	Identified as encountering Castile Brine.
16	22S-31E-17	WIPP-12	11/17/1978	Monitoring	Identified as encountering Castile Brine.
17	22S-32E-05	Bilbrey "5" Federal #1	11/26/1981	Oil Well	Identified as encountering Castile Brine.
18	22S-32E-15	Lechuza Federal #4	12/29/1992	Oil Well	Identified as encountering Castile Brine.
19	22S-32E-16	Kiwi "AKX" State #1	4/28/1992	Oil Well	Identified as encountering Castile Brine.
20	22S-32E-25	Covington "A" Federal #1	2/7/1975	Oil Well	Identified as encountering Castile Brine.
21	22S-32E-26	Culberson #1	12/15/1944	P&A	Identified as encountering Castile Brine.
22	22S-32E-34	Red Tank "34" Federal #1	9/23/1992	Oil Well	Identified as encountering Castile Brine.
23	22S-32E-36	Richardson State #1	7/20/1962	P&A	Identified as encountering Castile Brine.
24	22S-32E-36	Shell State #1	2/22/1964	Oil Well	Identified as encountering Castile Brine.

25	22S-33E-20	Cloyd Permit #1	9/7/1937	P&A	Identified as encountering Castile Brine.
26	22S-33E-20	Cloyd Permit #2	6/22/1938	P&A	Identified as encountering Castile Brine.
27	23S-30E-01	Hudson Federal #1	2/25/1974	SWD	Identified as encountering Castile Brine.
Castile Brine Encounters Since July 1995					
1	21S-31E-35	Lost Tank "35" State #4	09/11/200	Oil Well	Estimated several hundred barrels per hour. Continued drilling.
2	21S-31E-35	Lost Tank "35" State #16	2/6/2002	Oil Well	At 2,705 ft., encountered 1,000 barrels per hour. Shut-in to get room in reserve pit with pressure of 180 psi and water flow of 450 B/H. Two days later no water flow and full returns.
3	22S-31E-02	Graham "AKB" State #8	4/12/2002	Oil Well	Estimated 105 barrels per hour. Continued drilling
4	23S-30E-01	James Ranch Unit #63	12/23/1999	Oil Well	Sulfur water encountered at 2,900 ft. 35 ppm was reported but quickly dissipated to 3 ppm in a matter of minutes. Continued drilling.
5	23S-30E-01	Hudson "1" Federal #7	1/6/2001	Oil Well	Estimated initial flow at 400 to 500 barrels per hour with a total volume of 600 to 800 barrels. Continued drilling.
6	22S-30E-13	Apache "13" Federal "3	11/26/2003	Oil Well	Encountered strong water flow with blowing air at 2,850-3,315 ft. No impact on drilling process.
7	21S-31E-34	Jacque "AQJ" State #7	3/4/2005	Oil Well	Encountered water flow of 104 barrel per hour at 2,900 ft. No impact on drilling process.

Table 8: Plugged Well Information

#	Location	API#	Plug Date	R-111-P Area	Well Depth	Plug Depth	Plug Length
1	22S-28E-31	30-015-24773	2/17/2012	No	3,650	3385-3350 3200-3165 2400-0	35 ft 35 ft 2400 ft
2	22S-31E-6	30-015-21098	12/26/2011	Yes	14,050	CIBP 5848 3750-0	35 ft 3750 ft
3	23S-28E-9	30-015-23525	1/31/2012	No	12,852	12220-11198 10294-9772 9678-9434 9157-8950 6167-5967 4394-2618 1035-850 495-0	1022 ft 522 ft 244 ft 207 ft 200 ft 1776 ft 185 ft 495 ft
4	23S-28E-9	30-015-23759	3/12/2012	No	4,300	3600-3460 2600-2470 1030-920 490-0	140 ft 130 ft 110 ft 490 ft
5	23S-31E-9	30-015-26509	5/21/2012	Yes	15,175	CIBP 5000 4168-0	35 ft 4168 ft
6	23S-31E-12	30-015-30063	4/4/2012	No	8,450	5280-5122 4584-4140 1161-785 60-0	158 ft 444 ft 376 ft 60 ft
7	23S-31E-14	30-015-32866	12/14/2011	Yes	8,500	6950-6780 6100-5940 4500-818 135-0	170 ft 160 ft 3682 ft 135 ft
8	23S-34E-30	30-025-08489	4/4/2012	No	13,044	5653-4842 4041-3938 1319-1151 195-0	811 ft 103 ft 168 ft 195 ft
9	24S-31E-7	30-015-03699	9/27/2011	No	2,791	2778-2395 1050-920 350-0	383 ft 130 ft 350 ft
10	24S-31E-8	30-015-27228	4/24/2012	No	8,208	7882-7635 6083-5831 4223-3727 882-0	247 ft 252 ft 496 ft 882 ft
11	24S-31E-11	30-015-10259	9/20/2011	No	6,500	5480-5080 5040-914 465-0	400 ft 4126 ft 465 ft
12	25S-25E-1	30-015-21023	10/19/2011	No	11,850	3270-3169 1720-1305 407-0	101 ft 415 ft 407 ft
13	25S-26E-6	30-015-34523	4/22/2012	No	12,167	10435-10195 8510-8110 7407-7081 5355-5040 2622-2422 1825-1591 1575-1265 268-0	240 ft 400 ft 326 ft 315 ft 200 ft 234 ft 310 ft 268 ft

14	25S-26E-19	30-015-35420	10/13/2011	No	12,650	5090-4890 2775-2570 2570-2433 1891-1475 437-0	200 ft 205 ft 137 ft 416 ft 437 ft
15	25S-27E-23	30-015-37804	1/16/2012	No	92	92-0	92 ft
16	25S-32E-10	30-025-08175	6/5/2012	No	4,771	4654-4135 2890-2710 1272-1172 550-0	519 ft 180 ft 100 ft 550 ft
17	25S-32E-15	30-025-08183	11/23/2011	No	4,811	4650-4072 1206-956 818-457 450-0	578 ft 250 ft 361 ft 450 ft
18	25S-32E-15	30-025-08187	5/31/2012	No	4,727	4624-4199 2849-2632 1220-1013 421-80 80-0	425 ft 217 ft 207 ft 341 ft 80 ft
19	25S-32E-15	30-025-08190	5/30/2012	No	4,743	4580-4082 2896-2650 1227-1110 421-0	498 ft 246 ft 117 ft 421 ft
20	25S-32E-22	30-025-08222	6/6/2012	No	4,717	4609-4018 2805-2585 1180-1008 410-0	591 ft 220 ft 172 ft 410 ft
21	25S-35E-19	30-025-40435	5/20/2012	No	15,802	7887-7062 5635-4810 3000-2800 1212-807 157-0	825 ft 825 ft 200 ft 405 ft 157 ft
22	26S-28E-36	30-015-37941	3/9/2012	No	165	165-0	165 ft
23	26S-29E-23	30-015-33410	7/19/2012	No	5,640	5068-4821 3868-3737 2681-2564 1300-1070 730-120 120-0	247 ft 131 ft 117 ft 230 ft 610 ft 120 ft
24	26S-29E-23	30-015-33550	7/19/2012	No	5,322	5048-4670 3889-3565 3042-2630 2450-2220 1300-1070 671-65 65-0	378 ft 324 ft 412 ft 230 ft 230 ft 606 ft 65
25	26S-30E-8	30-015-25171	11/8/2011	No	7,400	CIBP 5447 5033-4933 3539-3439 970-870 60-0	35 ft 100 ft 100 ft 100 ft 60 ft

Table 9: Past Plugging Summary by Well Type

Type	CCA Well Count	CCA Frequency	CRA-2004 Well Count	CRA-2004 Frequency	CRA-2009 Well Count	CRA-2009 Frequency
I	61	32.5%	116	34.1%	131	30.5%
II	37	20%	60	17.7%	84	19.5%
III	64	34%	111	32.6%	142	33%
IV	19	10%	38	11.2%	52	12.1%
V	3	1.5%	10	2.9%	13	3%
VI	4	2%	5	1.5%	8	1.9%
TOTALS	188	100%	340	100%	430	100%

Table 10: Current Plugging Summary by Well Type for the CRA-2014

Type	CRA-2009	CRA-2009 Frequency	2008	2009	2010	2011	2012	Total	Current Frequency	Change
I	131	30.5%	1	6	2	3	4	147	26.9%	-3.6%
II	84	19.5%	5	6	12	3	0	110	20.1%	+0.6%
III	142	33.0%	4	1	9	5	2	163	29.9%	-3.1%
IV	52	12.1%	4	4	14	4	12	90	16.5%	+4.4%
V	13	3.0%	0	1	0	0	0	14	2.6%	-0.4%
VI	8	1.9%	2	1	1	5	5	22	4.0%	+2.1%
TOTALS	430	100.0%	16	19	38	20	23	546	100.0%	

NOTE: The 1996 Compliance Certification Application (CCA) used the 188 wells categorized into the above classifications to arrive at the percentage or frequency of each plugging event. The Compliance Recertification Application (CRA) followed up on that study and 152 wells were added to the original number to update the frequency. In 2003, 23 wells were plugged and abandoned in the New Mexico portion of the Delaware Basin. Three were ruled out because they were less than 2,150 feet deep. Twenty wells were categorized into one of the above plugging configurations and added to the count. For 2004, 25 wells were plugged and abandoned and were added to the count. In 2005, 24 wells were plugged and abandoned but only 20 wells were used since two wells were shallow and two did not have any plugging reports available at the time of this report. For 2006, 10 wells were plugged and abandoned in the New Mexico portion of the Delaware Basin and were added to the count. In 2007, 16 wells were plugged, with one being shallow. Thus, 15 wells were added to the above count. The change indicated above is between the current and the CRA frequencies for each type of plugging configuration.

Table 11: Seismic Activity in the Delaware Basin

County	No. of Events	Earliest Event	Latest Event	Smallest Magnitude	Largest Magnitude
Culberson	15	10/27/1992	6/28/2007	1.1	2.4
Eddy	19	11/28/1975	3/18/2012	-1.3	3.7
Lea	1	6/23/1993	6/23/1993	2.1	2.1
Loving	3	2/4/1976	4/28/1997	1.1	1.6
Pecos	19	1/30/1975	3/10/2010	1.0	2.6
Reeves	19	2/19/1976	3/2/2012	0.6	2.4
Ward	50	9/3/1976	7/1/2009	0.3	2.8
Winkler	9	9/24/1971	10/19/2007	0.0	3.0
TOTAL	135				

KEY:

Magnitude

- Less than 2 Very seldom ever felt
- 2.0 to 3.4 Barely felt
- 3.5 to 4.2 Felt as a rumble
- 4.3 to 4.9 Shakes furniture; can break dishes
- 5.0 to 5.9 Dislodges heavy objects; cracks walls
- 6.0 to 6.9 Considerable damage to buildings
- 7.0 to 7.3 Major damage to buildings; breaks underground pipes
- 7.4 to 7.9 Great damage; destroys masonry and frame buildings
- Above 8.0 Complete destruction; ground moves in waves

NOTE: Four of the nineteen seismic events in Eddy County can be directly attributed to mining activities.

Table 12: Nine-Township Injection and SWD Well Information

#	Location	API#	Status	Injection Zone	First Injection	Last Injection	Cumulative Bbl
1	21S-31E-33	30-015-29330	SWD	4,166-5,160	1998	June 2012	5,658,096
2	21S-32E-08	30-025-31412	SWD	4,826-5,978	1991	June 2012	14,018,079
3	21S-32E-31	30-025-31443	SWD	4,618-6,012	1992	June 2012	377,786
4	22S-30E-02	30-015-25758	Injection	7,200-7,264	1993	June 2012	21,673,409
5	22S-30E-02	30-015-26761	Injection	5,600-7,400	1991	June 2012	22,320,755
6	22S-30E-25	30-015-33439	SWD	5,678-7,682	2010	June 2012	981,521
7	22S-30E-27	30-015-04734	SWD	3,820-3,915	1981	June 2012	5,476,714
8	22S-31E-02	30-015-32440	Injection	6,989-7,020	2003	June 2012	2,412,936
9	22S-31E-24	30-015-26848	SWD	4,519-5,110	1991	June 2012	11,764,462
10	22S-31E-25	30-015-28281	Injection	7,050-7,068	1995	June 2012	11,511,739
11	22S-31E-35	30-015-26629	SWD	4,500-5,670	1991	June 2012	22,272,839
12	22S-31E-36	30-015-26171	SWD	4,500-5,700	1998	June 2012	213,867
13	22S-32E-05	30-025-27620	SWD	5,150-8,602	2004	June 2012	6,616,121
14	22S-32E-06	30-025-31227	SWD	4,626-5,730	2012	June 2012	554,593
15	22S-32E-07	30-025-31076	SWD	4,676-5,814	1991	June 2012	12,407,852
16	22S-32E-11	30-025-31716	SWD	5,200-8,706	1994	June 2012	2,859,021
17	22S-32E-14	30-025-08113	SWD	4,900-6,080	1994	June 2012	5,873,807
18	22S-32E-16	30-025-31644	SWD	5,582-6,380	2010	June 2012	666,975
19	22S-32E-16	30-025-31889	SWD	5,240-8,710	1995	June 2012	11,759,115
20	22S-32E-16	30-025-36006	SWD	5,858-6,450	2010	June 2012	1,226,217
21	22S-32E-17	30-025-31926	SWD	6,807-6,828	2007	June 2012	2,380,163
22	22S-32E-21	30-025-08109	SWD	4,755-5,110	1992	June 2012	3,721,392
23	22S-32E-27	30-025-32436	Injection	6,831-8,388	1998	June 2012	8,582,373
24	22S-32E-28	30-025-31754	SWD	4,690-5,800	1993	June 2012	4,971,618
25	22S-32E-31	30-025-20423	SWD	4,662-5,915	1993	June 2012	5,316,095
26	22S-32E-31	30-025-32093	SWD	4,590-5,626	2004	June 2012	850,875
27	22S-32E-32	30-025-36004	SWD	6,744-8,518	2010	June 2012	1,961,390
28	22S-32E-32	30-025-37799	SWD	5,754-6,500	2010	June 2012	1,634,550
29	22S-32E-35	30-025-33149	SWD	4,950-6,252	1995	June 2012	7,739,418
30	23S-30E-01	30-015-21052	SWD	4,040-4,825	2001	June 2012	3,354,398
31	23S-30E-16	30-015-20899	SWD	4,433-5,952	2003	June 2012	2,037,521

32	23S-30E-19	30-015-28901	SWD	3,402-4,609	1997	June 2012	3,451,241
33	23S-30E-20	30-015-29549	SWD	4,124-4,774	2006	June 2012	2,113,613
34	23S-30E-29	30-015-28808	SWD	5,479-7,220	1996	June 2012	4,266,779
35	23S-30E-33	30-015-26084	SWD	4,470-7,558	2005	June 2012	5,571,379
36	23S-30E-33	30-015-31744	SWD	4,546-6,760	2002	June 2012	5,476,329
37	23S-31E-02	30-015-05840	SWD	4,489-5,670	1997	June 2012	9,074,916
38	23S-31E-02	30-015-29792	SWD	4,500-5,850	1998	June 2012	9,600,298
39	23S-31E-02	30-015-35749	SWD	4,600-5,880	2010	July 2012	996,247
40	23S-31E-08	30-015-32619	SWD	7,256-7,530	2004	June 2012	2,270,374
41	23S-31E-09	30-015-33368	SWD	7,942-7,952	2005	June 2012	3,955,016
42	23S-31E-11	30-015-25419	SWD	5,210-5,800	2005	June 2012	1,095,536
43	23S-31E-13	30-015-28904	SWD	5,760-5,862	2005	June 2012	893,513
44	23S-31E-20	30-015-30605	Injection	7,740-7,774	2001	June 2012	6,766,328
45	23S-31E-25	30-015-28817	SWD	5,776-5,920	2008	June 2012	337,919
46	23S-31E-25	30-015-28859	SWD	5,236-5,498	2008	June 2012	861,645
47	23S-31E-26	30-015-20277	SWD	4,460-5,134	1992	June 2012	4,873,042
48	23S-31E-26	30-015-20302	SWD	4,390-6,048	1971	June 2012	6,903,358
49	23S-31E-27	30-015-27106	SWD	4,694-5,284	1998	June 2012	5,925,469
50	23S-31E-28	30-015-26194	SWD	4,295-5,570	1993	June 2012	6,207,664
51	23S-31E-35	30-015-25640	SWD	4,484-5,780	1993	June 2012	7,593,595
52	23S-31E-36	30-015-20341	SWD	5,980-6,560	1994	June 2012	24,817,485
53	23S-32E-04	30-025-31650	SWD	4,884-5,886	2003	June 2012	4,202,003
54	23S-32E-07	30-025-33398	SWD	4,660-6,270	2009	June 2012	959,116
55	23S-32E-14	30-025-26844	SWD	5,496-6,014	1991	June 2012	1,935,010
56	23S-32E-15	30-025-35524	SWD	5,786-5,942	2008	June 2012	255,471
57	23S-32E-23	30-025-33653	SWD	5,954-6,064	2000	June 2012	1,632,798
58	23S-32E-24	30-025-33521	SWD	5,925-6,042	2001	June 2012	1,832,719
59	23S-32E-29	30-025-31515	SWD	4,844-4,944	1992	July 2012	10,997,400
60	23S-32E-31	30-025-32868	SWD	5,150-5,700	1996	June 2012	3,272,416
61	23S-32E-36	30-025-31929	SWD	5,364-6,138	1995	June 2012	4,016,484

NOTE: Information collected from New Mexico Oil Conservation Division (OCD) offices in Artesia and Hobbs, New Mexico. Also, cumulative barrels information is collected from the Internet site maintained by the New Mexico Institute of Mining and Technology on behalf of the New Mexico OCD (NMIMT).

Table 13: Brine Well Status in the Delaware Basin

County	Location	API#	Well Name and No.	Operator	Status
Eddy	22S-26E-36	30-015-21842	City Of Carlsbad #WS-1	Key Energy Services, LLC	Plugged Brine Well
Eddy	22S-27E-03	30-015-20331	Tracy #3	Ray Westall	Plugged Brine Well
Eddy	22S-27E-17	30-015-22574	Eugenie #WS-1	I & W Inc.	Plugged Brine Well
Eddy	22S-27E-17	30-015-23031	Eugenie #WS-2	I & W Inc.	Plugged Brine Well
Eddy	22S-27E-23	30-015-28083	Dunaway #1	Mesquite SWD, Inc.	Active Brine Well
Eddy	22S-27E-23	30-015-28084	Dunaway #2	Mesquite SWD, Inc.	Active Brine Well
Loving	Blk 29-03	42-301-10142	Lineberry Brine Station #1	Chance Properties Company	Active Brine Well
Loving	Blk 01-82	42-301-30680	Chapman Ford #BR1	Herricks & Son Co.	Plugged Brine Well
Loving	Blk 33-80	42-301-80318	Mentone Brine Station #1D	Basic Energy Services, LP	Active Brine Well
Loving	Blk 29-28	42-301-80319	East Mentone Brine Station #1	Permian Brine Sales, Inc.	Plugged Brine Well
Loving	Blk 01-83	42-301-80320	North Mentone #1	Chance Properties Company	Active Brine Well
Reeves	Blk 56-30	42-389-00408	Orla Brine Station #1D	Mesquite SWD, Inc.	Active Brine Well
Reeves	Blk 04-08	42-389-20100	North Pecos Brine Station #WD-1	Chance Properties Company	Active Brine Well
Reeves	Blk 07-21	42-389-80476	Coyanosa Brine Station #1	Chance Properties Company	Active Brine Well
Ward	Blk 17-20	42-475-31742	Pyote Brine Station #WD-1	Chance Properties Company	Active Brine Well
Ward	Blk 01-13	42-475-34514	Quito West Unit #207	Seaboard Oil Co.	Active Brine Well
Ward	Blk 34-200	42-475-20329	Barstow Brine Station #1	Basic Energy Services, LP	Active Brine Well
Ward	Blk 34-174	42-475-82265	Barstow Brine Station #1	Energy Equity Company	Active Brine Well